



42 GREENE STREET LL NEW YORK NY 10013
T 212.355.0625 F 212.355.0628 WWW.OASIQ.US



**MACHAR 280 Dining Table
with Teak Legs/HPL Top**
W 110 1/4" D 39 3/8" H 29 1/2"
158.4 lbs
Powder coated aluminum,
HPL & teak

MACHAR: TABLE TOP



HPL White



HPL Black

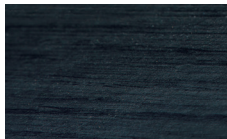

HPL Nordic Black

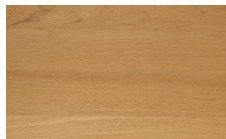

Teak



Ceramic White

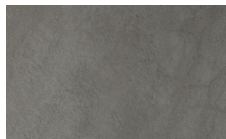

Ceramic Grey

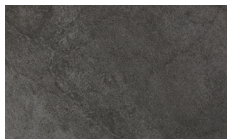

Ceramic Anthracite

MACHAR: FRAME/LEGS

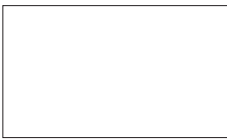

White



Anthracite



Teak

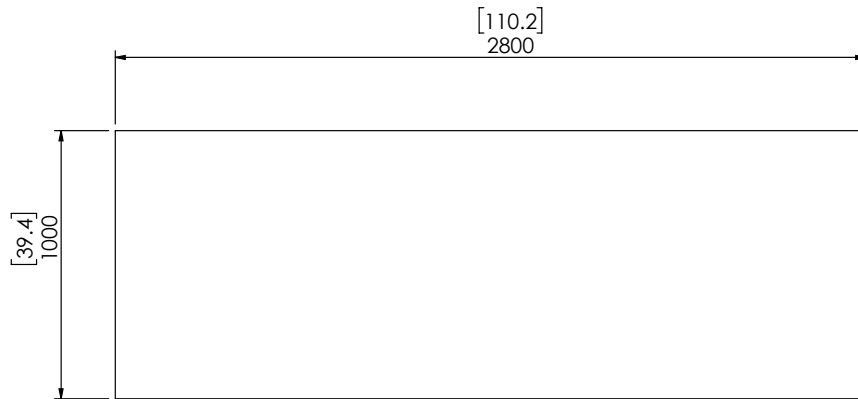

TOP VIEW

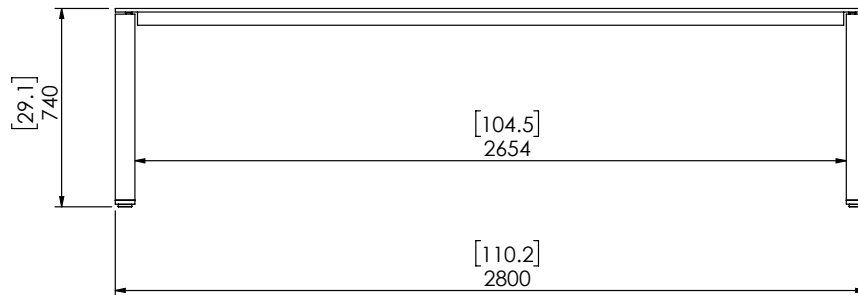
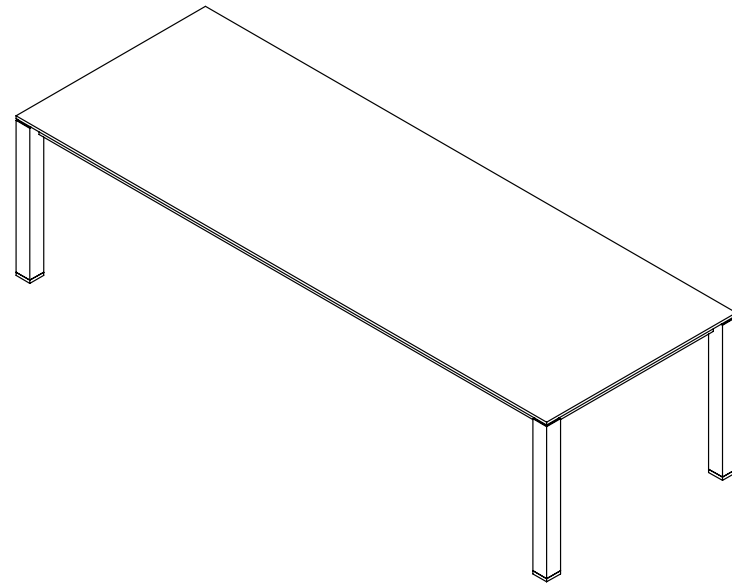

FRONT VIEW

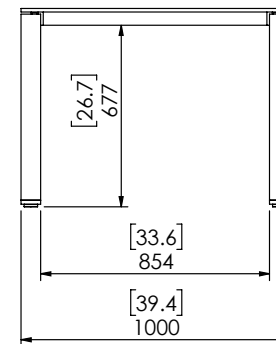

SIDE VIEW