



42 GREENE STREET LL NEW YORK NY 10013
T 212.355.0625 F 212.355.0628 WWW.OASIQ.US



**MACHAR 240 Dining Table
with Teak Legs/HPL Top**

W 94 1/2" D 39 3/8" H 29 1/2"

140.2 lbs

Powder coated aluminum, teak & HPL

MACHAR: TABLE TOP



HPL White



HPL Black

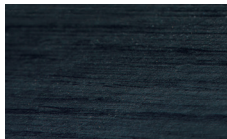

HPL Nordic Black

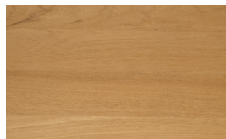

Teak



Ceramic White

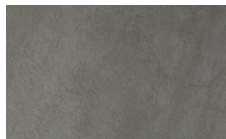

Ceramic Grey

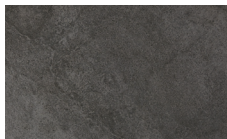

Ceramic Anthracite

MACHAR: FRAME/LEGS

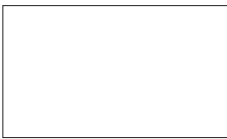

White



Anthracite



Teak

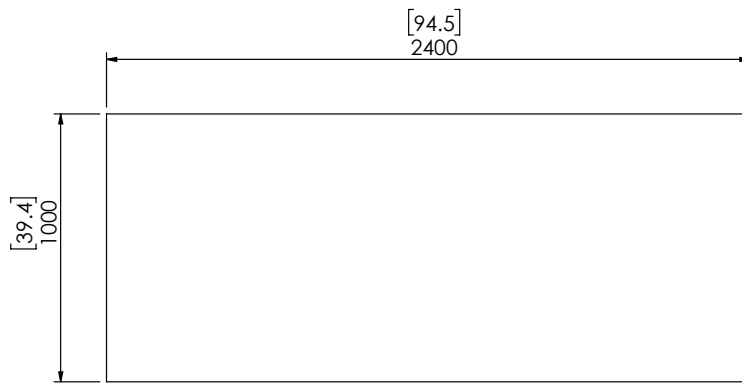

TOP VIEW

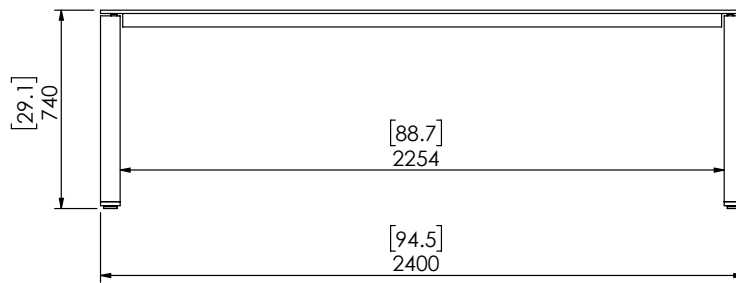
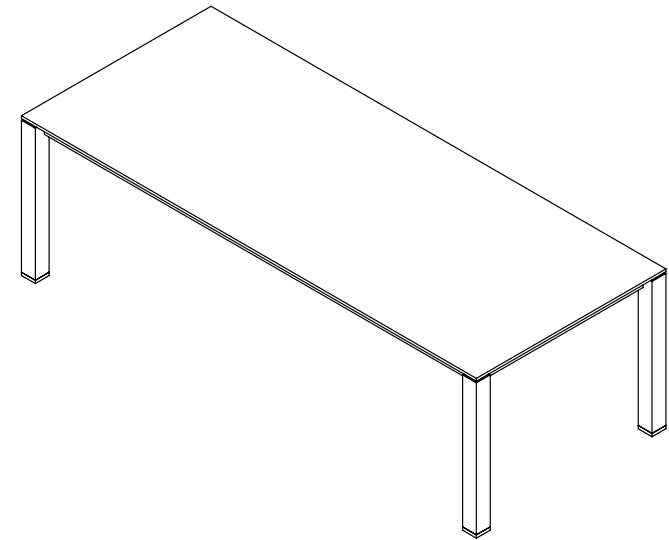

FRONT VIEW

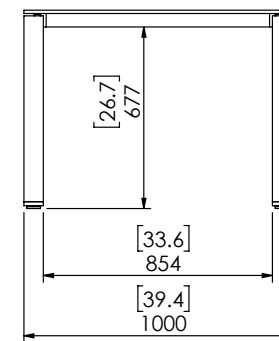

SIDE VIEW